

TMBF310

SINGLE PHASE 3.0AMPS. GLASS PASSIVATED BRIDGE RECTIFIERS

FEATURE

- . Glass passivated junction.
- . Ideal for printed circuit board.
- . Reliable low cost construction utilizing molded plastic technique.
- . High surge current capability.
- . High temperature soldering guaranteed: 260°C/10 seconds at terminals.

MECHANICAL DATA

- . Case Material: "Green" Molding compound, UL flammability classification rating 94V-0, "Halogen free"
- . Moisture sensitivity level: level 2a, per J-STD-020
- . Polarity: Polarity as marked on the body
- . Weight: 0.204g (approximately)

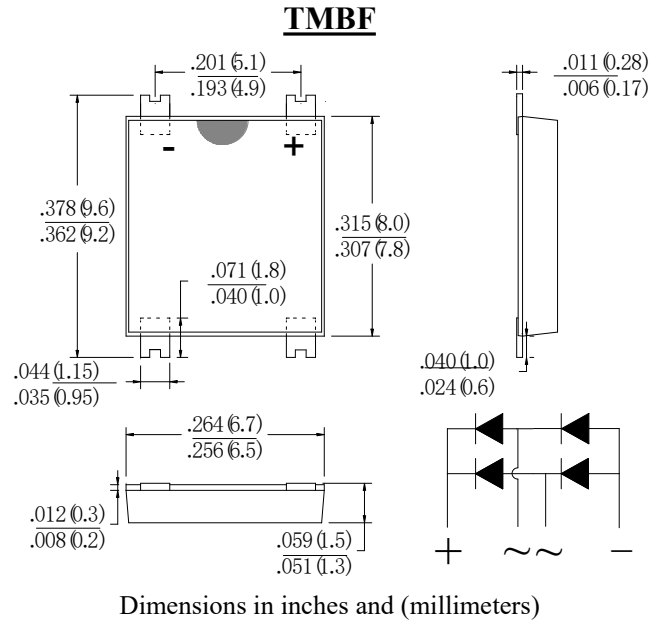

Single phase, half wave, 60Hz, resistive or inductive load. For capacitive load, derate current by 20%

MAXIMUM RATINGS (T_C=25°C unless otherwise noted)

Parameter	SYMBOL	TMBF310	Units
	Marking	TMBF310	
Maximum Recurrent Peak Reverse Voltage	V_{RRM}	1000	V
Maximum RMS Voltage	V_{RMS}	700	V
Maximum DC blocking Voltage	V_{DC}	1000	V
Average Forward Rectified Current at T _C ≤ 90°C	$I_{F(AV)}$	3	A
Non-repetitive forward surge current, 8.3ms half sine-wave	I_{FSM}	95	A
I ² t Rating for Fusing (t < 8.3ms)	I^2t	37.45	A ² Sec
Minimum Reverse Recovery Time (Note 1)	t_{rr}	800	nS
Typical Junction Capacitance (Note 2)	C_J	50	pF
Operation Junction and Storage Temperature	T_J, T_{STG}	-55 to + 150	°C

ELECTRICAL CHARACTERISTICS (T_C=25°C unless otherwise noted)

Parameter	SYMBOL	Min	Typ	Max	Units
Reverse Breakdown Voltage at I _r =0.01mA	V_{BR}	1000	-----	-----	V
Instantaneous Forward voltage at 3A	V_F	-----	0.93	1.1	V
reverse current at rated DC blocking voltage	I_R	-----	-----	5.0	uA
				200.0	

THERMAL CHARACTERISTICS (T_C=25°C unless otherwise noted)

Parameter	SYMBOL	TMBF310	Units
Typical Thermal Resistance (Note 3)	$R_{(JA)}$ $R_{(JC)}$	85 8	°C/W

Note: 1. Test Conditions: I_F=0.5A, I_R=1.0A, I_{RR}=0.25A

2. Measured at 1.0 MHz and applied reverse voltage of 4.0Vdc

3. Measured on P.C.Board with 15.0mm*15.0mm*1.6mm Copper Pad Areas

RATING AND CHARACTERISTIC CURVES

FIG.1-TYPICAL FORWARD CURRENT DERATING CURVE

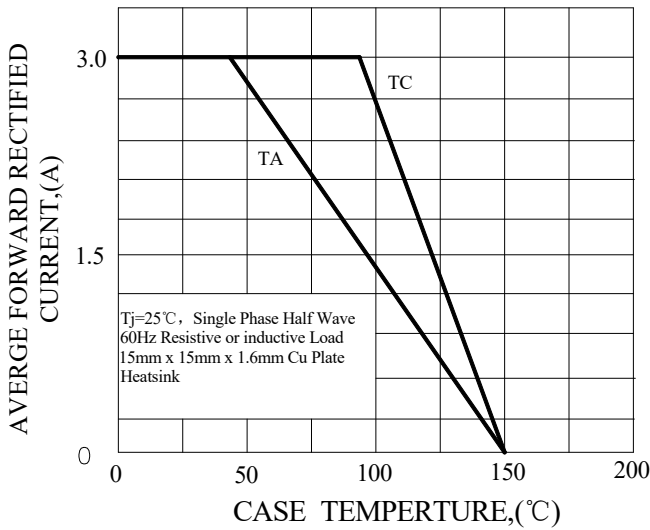

FIG.2-TYPICAL INSTANTANEOUS FORWARD CHARACTERISTICS

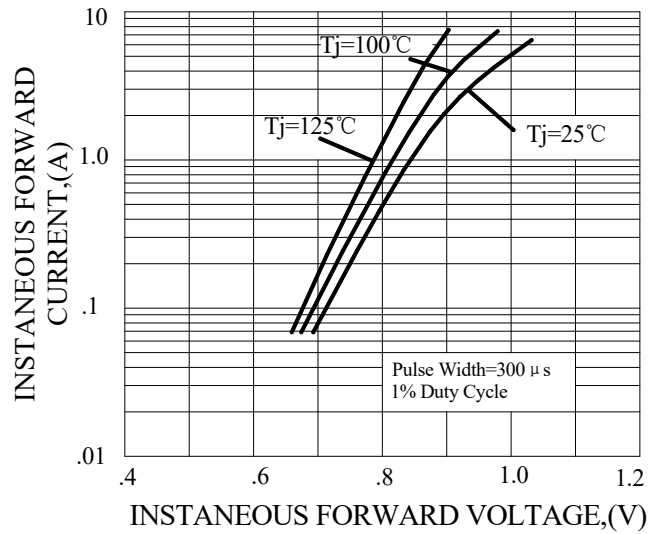

FIG.3-MAXIMUN NON-REPETITIVE FORWARD SURGE CURRENT

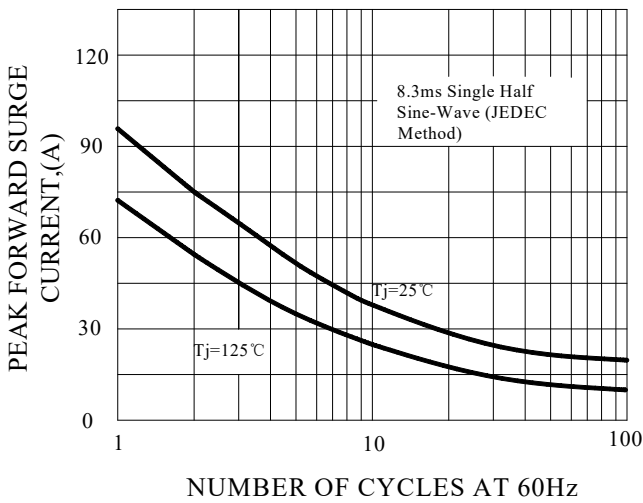

FIG.4-TYPICAL REVERSE CHARACTERISTICS

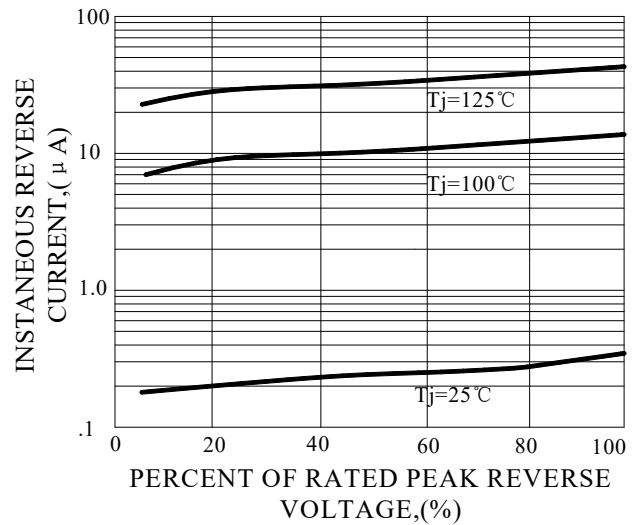
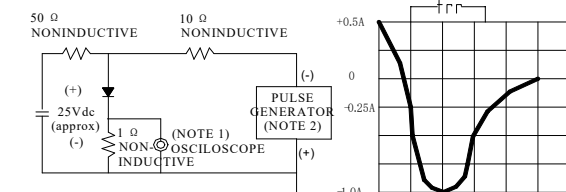
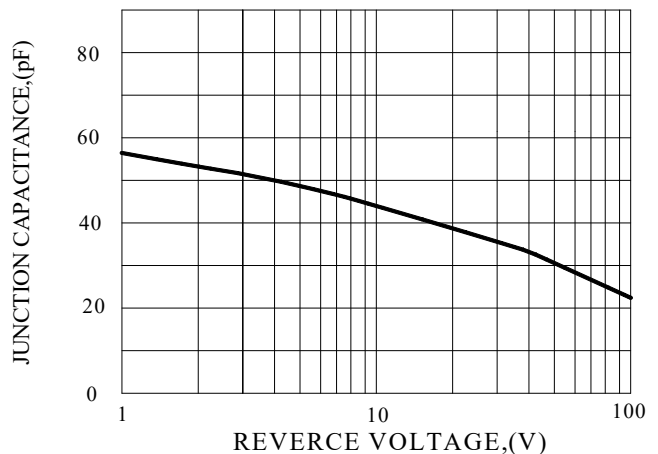

FIG.5-TEST CIRCUIT DIAGRAM AND REVERSE RECOVERY TIME CHARACTERISTIC



NOTES: 1. Rise Time=7ns max, Input Impedance= 1 megohm.22pF.
 2. Rise Time=10ns max, Source Impedance= 50 ohms.

FIG.6-TYPICAL JUNCTION CAPACITANCE



Marking and packaging illustration

1、Marking

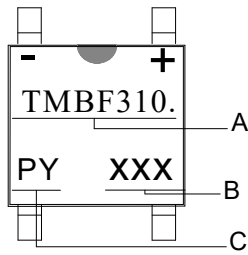

SYMBOL	Explanation
A	Product Name
B	Date Code
C	Trademark

2、Packaging

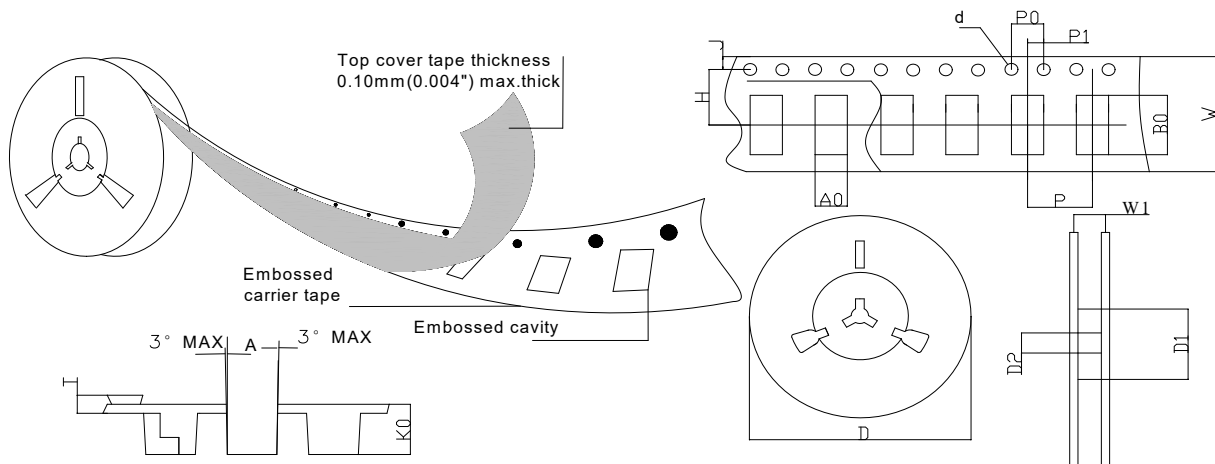

SPECIFICATIONS mm(inch)		PACKAGE	SPECIFICATIONS mm(inch)		PACKAGE
ITEM	SYM BOL	TMBF	ITEM	SYM BOL	TMBF
Carrier width	A	7.0(0.276)Max	Carrier depth	K	1.70(0.067)Typ
Carrier length	B	9.9(0.390)Max	Punch hole pitch	P	12.00(0.472)Typ
Sprocket hole	d	∅1.55(0.061)Typ	Sprocket hole pitch	P0	4.00(0.157)Typ
Reel outer diameter	D	330.0(13.0)Typ	Embossment center	P1	2.00(0.079)Typ
Reel inner diameter	D1	50.0(1.969)Min	Overall tape thickness	T	0.33(0.013)Typ
Feed hole diameter	D2	13.0(0.512)Typ	Tape width	W	16.0(0.630)Typ
Sprocket hole position	J	1.75(0.069)Typ	Reel width	W1	12.4(0.488)Min
Punch hole position	H	7.50(0.295)Typ			